

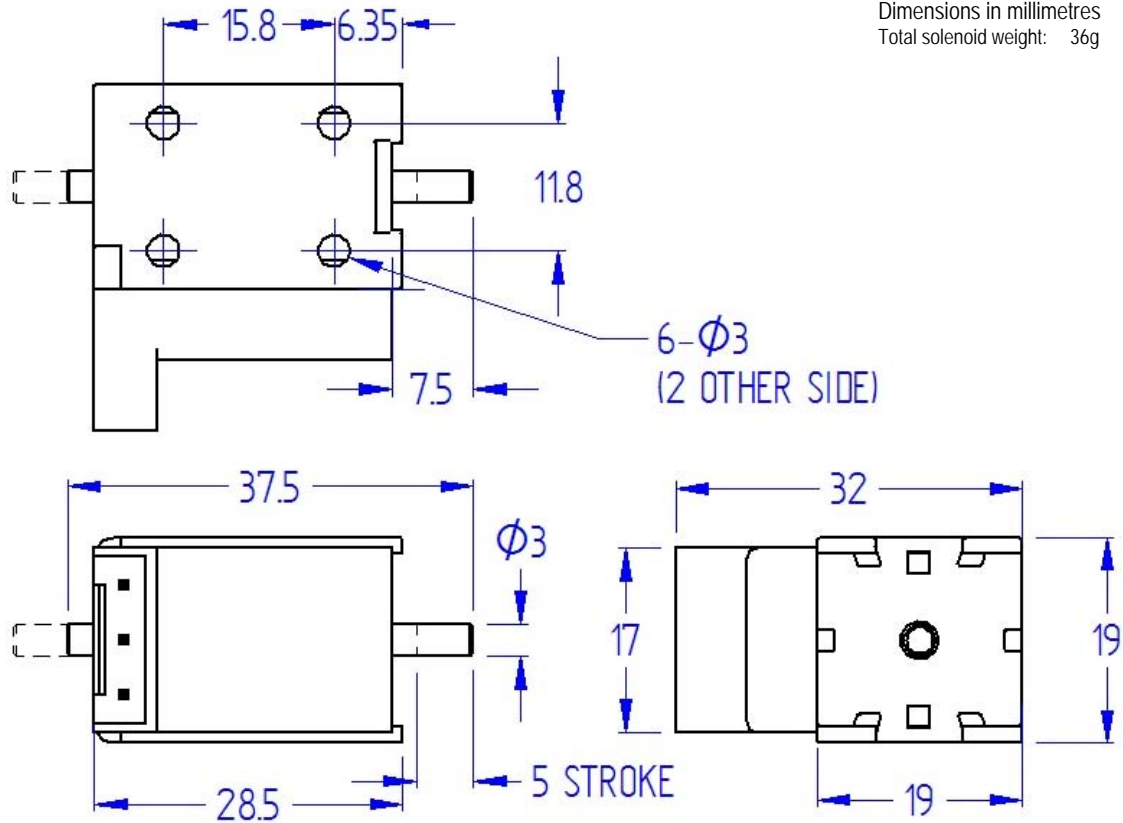

Permanent Magnet Latching Solenoid

SK0628



Dimensions in millimetres
Total solenoid weight: 36g

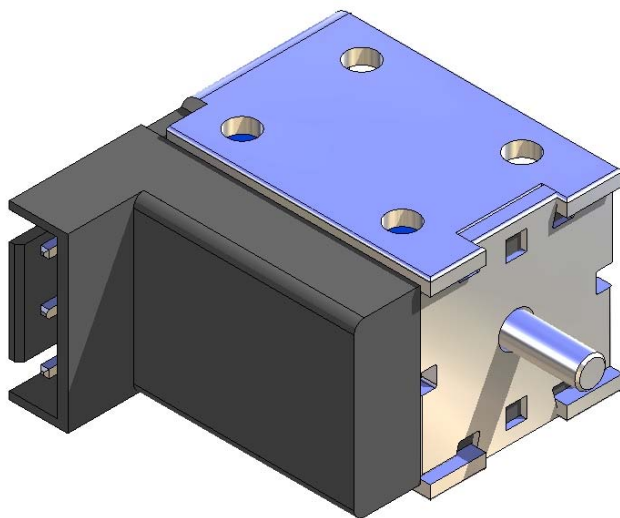

- Bi-stable pull and thrust
- Terminal pin connection with optional flying leads/connector
- Corrosion resistant plated parts
- Up to 10⁶ operations
- Customised pin ends and fixing centres
- Optional voltages



SOLENTEC
SOLENOID TECHNOLOGY