

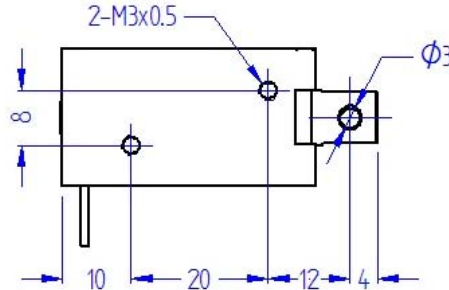

D - Frame Solenoid

SD0837

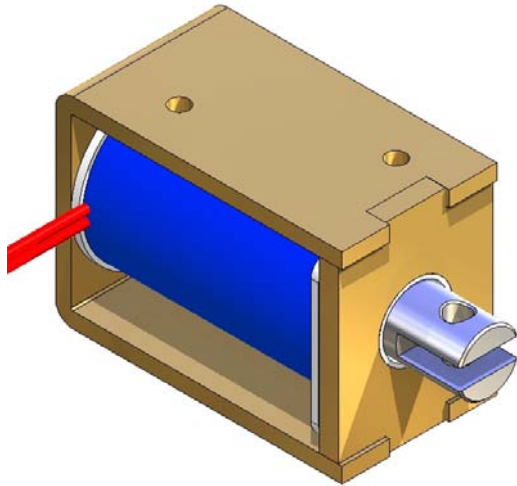

Dimensions in millimetres
Total solenoid weight: 96g
Plunger weight: 12g

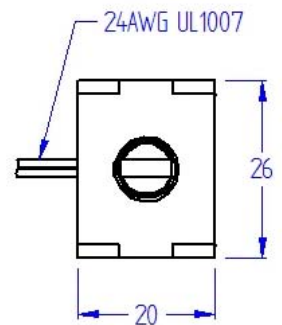
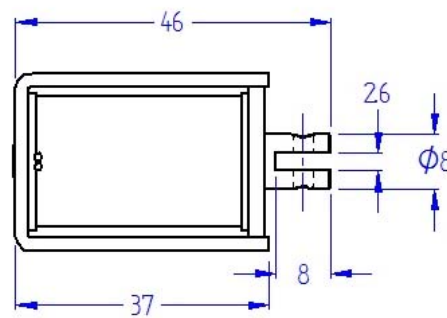

Force/Stroke Characteristics

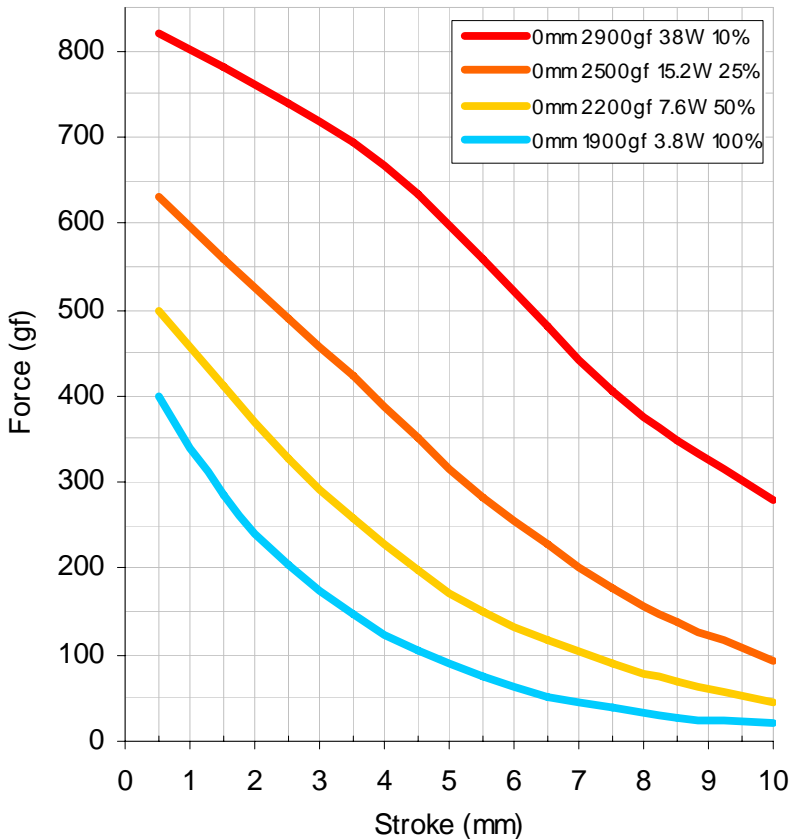

- Pull or thrust type
- Flying leads with optional terminals/connector
- Corrosion resistant plated parts
- Optional return spring
- Customised plunger ends and fixing centres
- Optional voltages and duty ratings

