

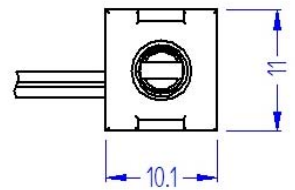

D - Frame Solenoid

SD0420

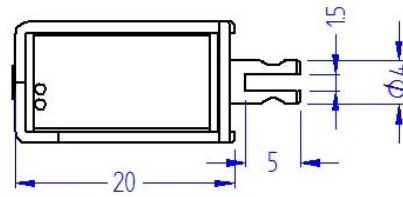
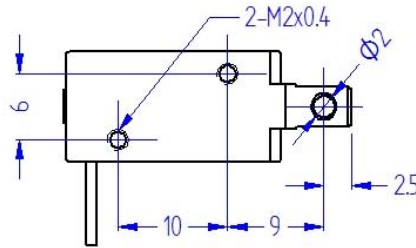
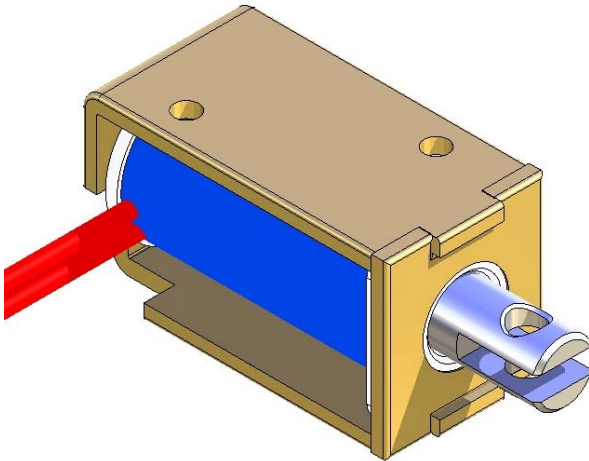

Dimensions in millimetres
Total solenoid weight: 10g
Plunger weight: 2g

Force/Stroke Characteristics

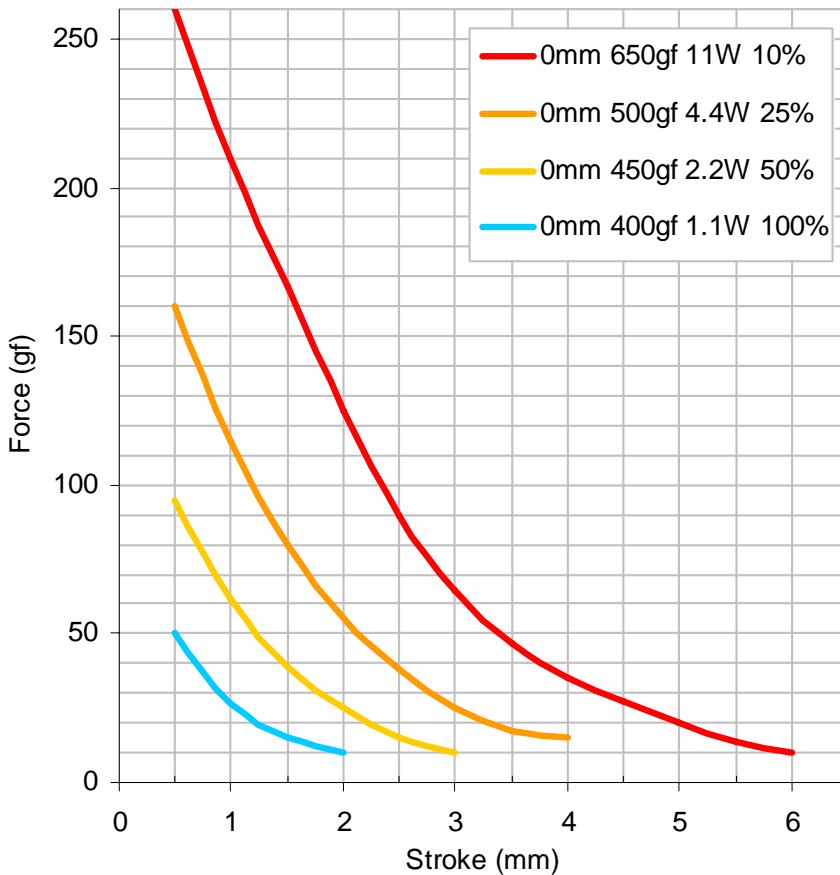

- Pull or thrust type
- Flying leads with optional terminals
- Corrosion resistant plated parts
- Optional return spring
- Customised plunger ends and fixing centres
- Optional voltages and duty ratings

SOLENTEC
SOLENOID TECHNOLOGY